

MINIATURE HERMETIC ELECTRONIC CONNECTORS—DRTBH SERIES

MIL-DTL-24308 TYPE D-SUB THRU BULKHEAD, COMMERCIAL EQUAL
HERMETIC GLASS-TO-METAL SEALED
(VACUUM / PRESSURE FEED THRUS)

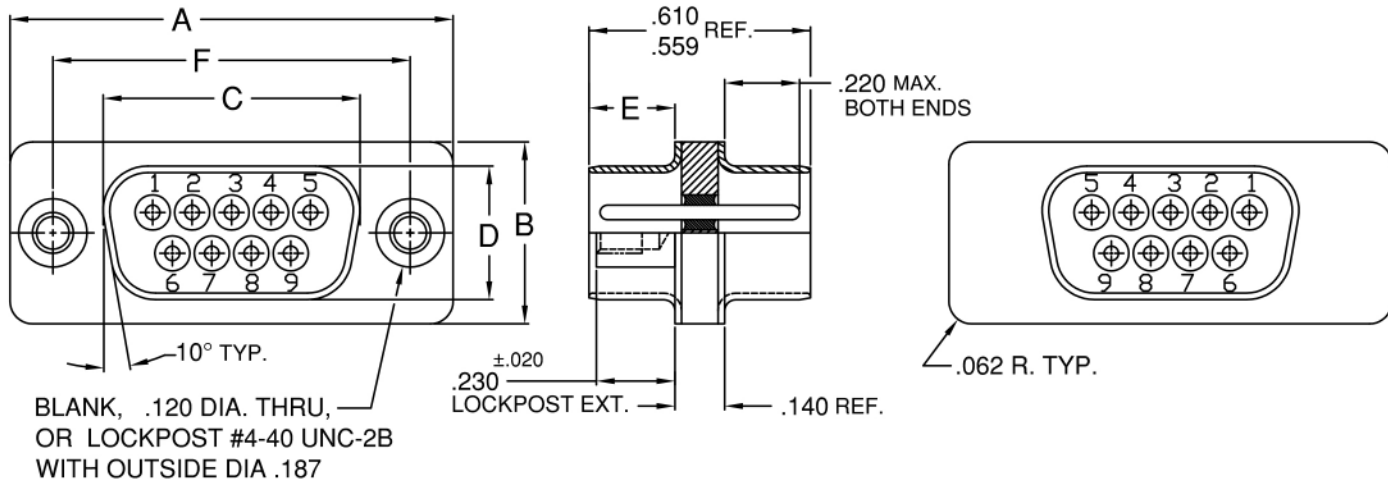

PART NO.	A	B	C	D	E	F
DRTBH1-9P-*	±.015	±.010	±.010	±.010	±.010	±.005
DRTBH2-15P-*	1.213	.498	.703	.366	.235	.984
DRTBH3-25P-*	1.541	.498	1.029	.366	.235	1.312
DRTBH4-37P-*	2.088	.498	1.571	.366	.230	1.852
DRTBH5-50P-*	2.729	.498	2.219	.366	.230	2.500
DRTBH5-50P-*	2.635	.610	2.115	.477	.230	2.406

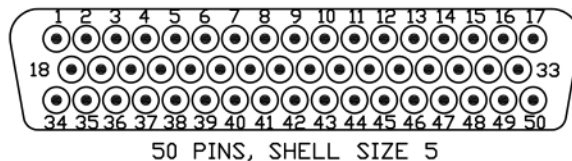
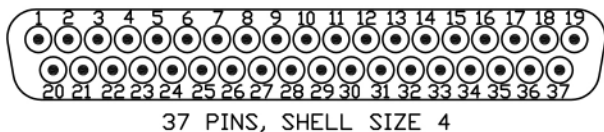
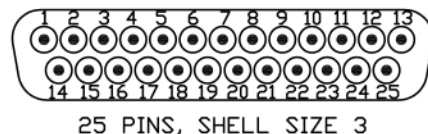
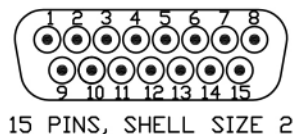
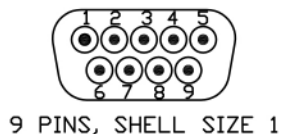

ENGAGING FACE PIN INSERTS

*ADD SUFFIX NUMBER FOR MODIFICATION (THRU HOLES, LOCKPOSTS, PLATING) - CONSULT FACTORY.

MATERIAL: STANDARD IS CRS SHELL AND 52 NICKEL ALLOY PINS.

STANDARD FINISH IS TIN PLATED SHELL AND PINS.

OTHER FINISHES ALSO AVAILABLE (GOLD, NICKEL, etc.) - CONSULT FACTORY.

SPECIALS CAN BE SUPPLIED TO MEET CUSTOMER SPECIFICATIONS - CONSULT FACTORY.

OUR CONNECTORS MATE WITH ANY PLUG WITH SOCKET CONTACTS WHICH MEET THE DIMENSIONAL REQUIREMENTS OF MIL-DTL-24308

GENERAL SPECIFICATIONS

AIR LEAKAGE: 1.04×10^{-5} CM³/SEC AT 15psi

INSULATION RESISTANCE: 5,000 megohms AT 500VDC

OPERATING TEMPERATURE: -67°F TO +257°F (-55°C TO +125°C)

CURRENT RATING: 5 AMPS

PART NUMBERING SYSTEM

DRTBH 1 - 9 P - ***

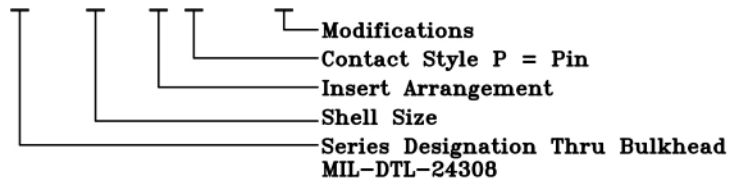

ALSO AVAILABLE D-SUB
DRH SERIES

STANDARD
LOCKPOSTS
THRU HOLES

CONSULT FACTORY

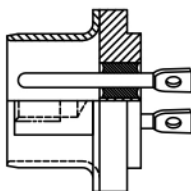

Detronics Corporation

13071 ROSECRANS AVE, SANTA FE SPRINGS, CA 90670

TELE: (626) 579-7130 FAX: (626) 579-1936

www.detronics.com